



# Safety Barrier Guidelines for Residential Pools

**Preventing Child Drownings**

U.S. Consumer Product  
Safety Commission





This document is in the public domain. Therefore it may be reproduced, in part or in whole, without permission by an individual or organization. However, if it is reproduced, the Commission would appreciate attribution and knowing how it is used.

For further information, write:

**U.S. Consumer Product Safety Commission**

**Office of Communications**

**4330 East West Highway**

**Bethesda, Md. 20814**

**[www.cpsc.gov](http://www.cpsc.gov)**

CPSC is charged with protecting the public from unreasonable risks of injury or death associated with the use of the thousands of consumer products under the agency's jurisdiction.

Many communities have enacted safety regulations for barriers at residential swimming pools—in ground and above ground. In addition to following these laws, parents who own pools can take their own precautions to reduce the chances of their youngsters accessing the family or neighbors' pools or spas without supervision. This booklet provides tips for creating and maintaining effective barriers to pools and spas.



Each year, thousands of American families suffer swimming pool tragedies—drownings and near-drownings of young children. The majority of deaths and injuries in pools and spas involve young children ages 1 to 3 and occur in residential settings. These tragedies are preventable.

This U.S. Consumer Product Safety Commission (CPSC) booklet offers guidelines for pool barriers that can help prevent most submersion incidents involving young children. This handbook is designed for use by owners, purchasers, and builders of residential pools, spas, and hot tubs.

The swimming pool barrier guidelines are not a CPSC standard, nor are they mandatory requirements. CPSC believes that the safety features recommended in this booklet will help make pools safer, promote pool safety awareness, and save lives. Barriers are not the sole method to prevent pool drowning of young children and cannot replace adult supervision.

Some states and localities have incorporated these guidelines into their building codes. Check with your local authorities to see what is required in your area's building code or in other regulations.



## Swimming Pool Barrier Guidelines

Many of the nearly 300 children under 5 who drown each year in backyard pools could be saved if homeowners completely fenced in pools and installed self-closing and self-latching devices on gates.

Anyone who has cared for a toddler knows how fast young children can move. Toddlers are inquisitive and impulsive and lack a realistic sense of danger. These behaviors make swimming pools particularly hazardous for households with young children.

CPSC reports that child drownings are the second leading cause of accidental death around the home for children under 5 years of age. In some southern or warm weather states, drowning is the leading cause of accidental death in the home for children under 5.

CPSC staff has reviewed a great deal of data on drownings and child behavior, as well as information on pool and pool barrier construction. The staff concluded that the best way to reduce child drownings in residential pools is for pool owners to construct and maintain barriers that will help to prevent young children from gaining access to pools and spas.

The guidelines provide information for pool and spa owners to use to prevent children from entering the pool area unaccompanied by a supervising adult. They take into consideration the variety of barriers (fences) available and where each might be vulnerable to a child wanting to get on the other side.

The swimming pool barrier guidelines are presented with illustrated descriptions of pool barriers. The definition of pool includes spas and hot tubs. The swimming pool barrier guidelines therefore apply to these structures as well as to above ground pools, and may include larger portable pools.

### ***Pool and Spa Submersions: Estimated Injuries and Reported Fatalities\****

CPSC publishes an annual report on submersion incidents. Key findings from the 2012 report include:

- Nearly 300 children younger than 5 drown in swimming pools and spas each year representing 75 percent of the 390 fatalities reported for children younger than 15.
- Children aged 1 to 3 years (12 months through 47 months) represented 67 percent of the reported fatalities and 66 percent of reported injuries in pools and spas.
- Over 4,100 children younger than 5 suffer submersion injuries and require emergency room treatment; about half are seriously injured and are admitted to the hospital for further treatment.
- The majority of drownings and submersion injuries involving victims younger than 5 occur in pools owned by the family, friends or relatives.
- The majority of estimated emergency department-treated submersion injuries and reported fatalities were associated with pools.
- Portable pools accounted for 10 percent of the total fatalities (annual average of 40) for children younger than 15.

*\*The report presents average annual estimates for emergency department-treated injuries for 2009 through 2011 and average annual estimates for fatal submersions for 2007 through 2009, as reported to CPSC staff. The years for reported injury and fatality statistics differ due to a lag in fatality reporting.*





## Barriers

Barriers are not child proof, but they provide layers of protection for a child when there is a lapse in adult supervision. Barriers give parents additional time to find a child before the unexpected can occur.

Barriers include a fence or wall, door alarms for the house, and a power safety cover over the pool. Use the following recommendations as a guide.

### Barrier Locations

Barriers should be located so as to prohibit permanent structures, equipment or similar objects from being used to climb the barriers.

### Fences

A fence completely surrounding the pool is better than one with the house serving as the fourth side. Fences should be a minimum of 4 feet high, although fences 5 feet or higher are preferable.

If the home serves as one side of the barrier install **door alarms** on all doors leading to the pool area. Make sure the doors have self-closing and self-latching devices or locks beyond the reach of children to prevent them from opening the door and gaining access to the pool.

**Pool covers** add another layer of protection and there are a wide variety of styles on the market. Keep pool covers well-maintained and make sure the control devices are kept out of the reach of children.

A successful pool barrier prevents a child from getting **OVER, UNDER, or THROUGH** and keeps the child from gaining access to the pool except when supervising adults are present.

### How To Prevent a Child from Getting OVER a Pool Barrier

A young child can get over a pool barrier if the barrier is too low or if the barrier has handholds or footholds to use when climbing. The top of a pool barrier should be at least 48 inches above grade, measured on the side of the barrier which faces away from the swimming pool. Some states, counties or municipalities require pool barriers of 60 inches.

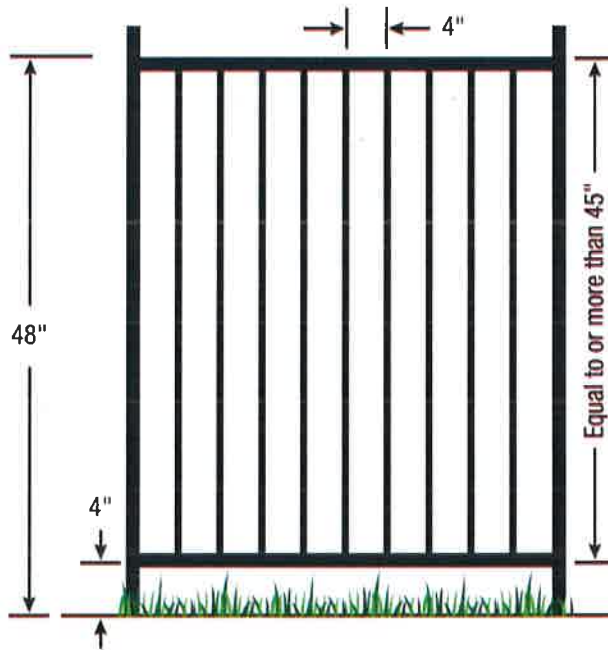

Eliminate handholds and footholds and minimize the size of openings in a barrier's construction.

Figure 1

### For a Solid Barrier

No indentations or protrusions should be present, other than normal construction tolerances and masonry joints.

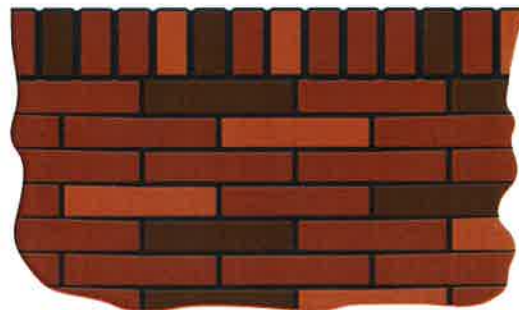

Figure 2

## For a Barrier (Fence) Made Up of Horizontal and Vertical Members

If the distance between the top side of the horizontal members is less than 45 inches, the horizontal members should be on the swimming pool side of the fence.

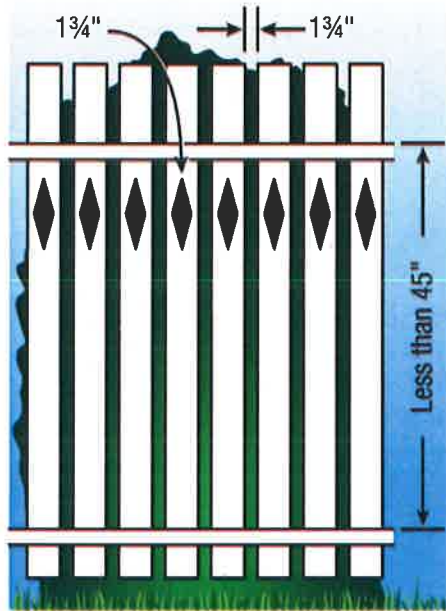

Figure 3

The spacing between vertical members and within decorative cutouts should not exceed  $1\frac{3}{4}$  inches. This size is based on the foot width of a young child and is intended to reduce the potential for a child to gain a foothold and attempt to climb the fence.

If the distance between the tops of the horizontal members is more than 45 inches, the horizontal members can be on the side of the fence facing away from the pool. The spacing between vertical members should not exceed 4 inches. This size is based on the head breadth and chest depth of a young child and is intended to prevent a child from passing through an opening. If there are any decorative cutouts in the fence, the space within the cutouts should not exceed  $1\frac{3}{4}$  inches.

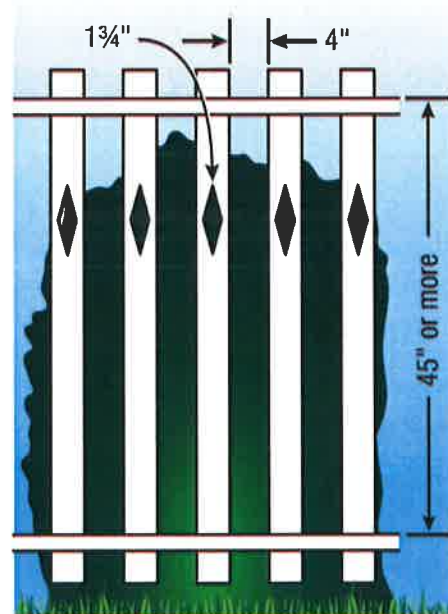

Figure 4



### For a Chain Link Fence

The mesh size should not exceed  $1\frac{1}{4}$  inches square unless slats, fastened at the top or bottom of the fence, are used to reduce mesh openings to no more than  $1\frac{3}{4}$  inches.

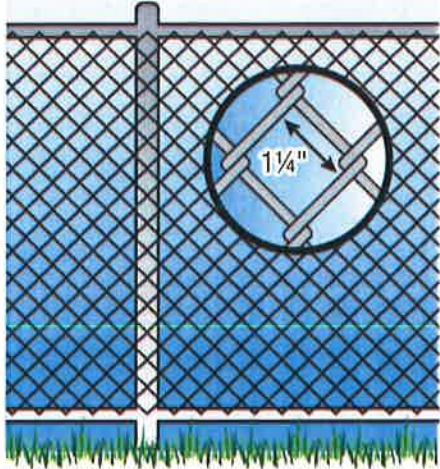

Figure 5

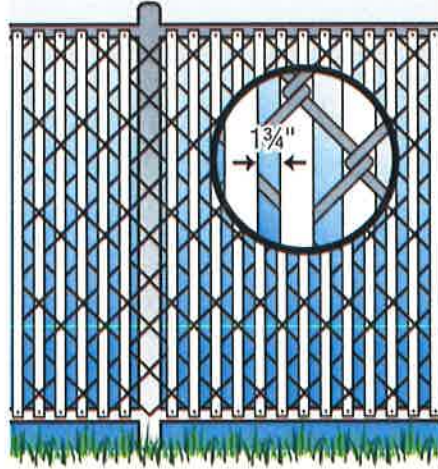

Figure 6

### For a Fence Made Up of Diagonal Members or Latticework

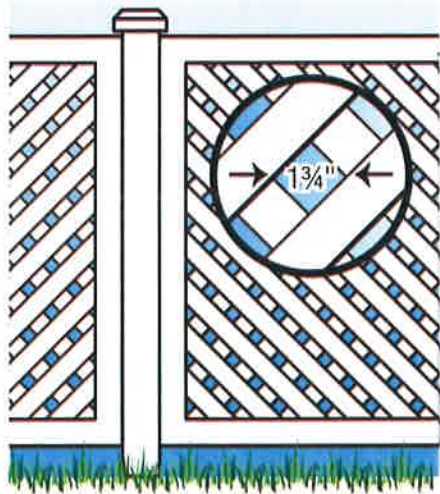

Figure 7

The maximum opening in the lattice should not exceed  $1\frac{3}{4}$  inches.

## For Above Ground Pools

Above ground pools should have barriers. The pool structure itself serves as a barrier or a barrier is mounted on top of the pool structure.

There are two possible ways to prevent young children from climbing up into an above ground pool. The steps or ladder can be designed to be secured, locked or removed to prevent access, or the steps or ladder can be surrounded by a barrier such as those described in these guidelines

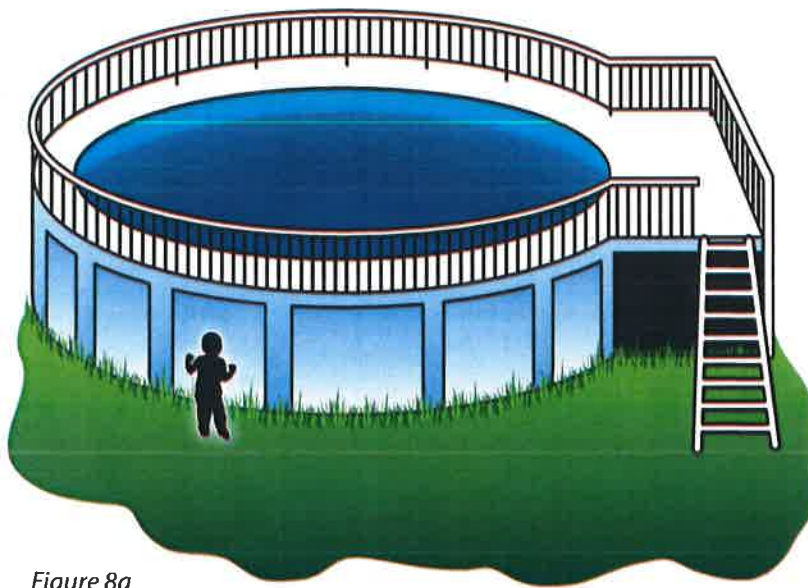

Figure 8a



Figure 8b



Figure 8c

## Above Ground Pool with Barrier on Top of Pool

If an above ground pool has a barrier on the top of the pool, the maximum vertical clearance between the top of the pool and the bottom of the barrier should not exceed 4 inches.

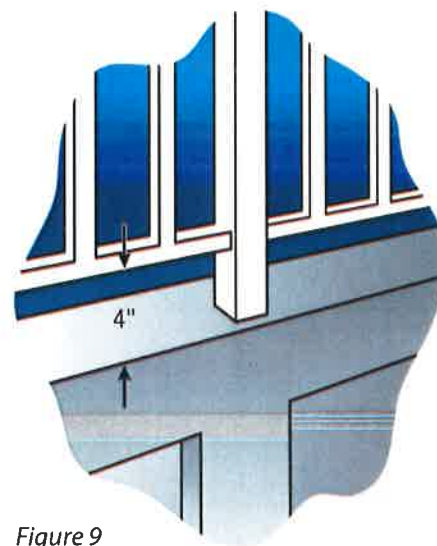

Figure 9

## How to Prevent a Child from Getting UNDER a Pool Barrier

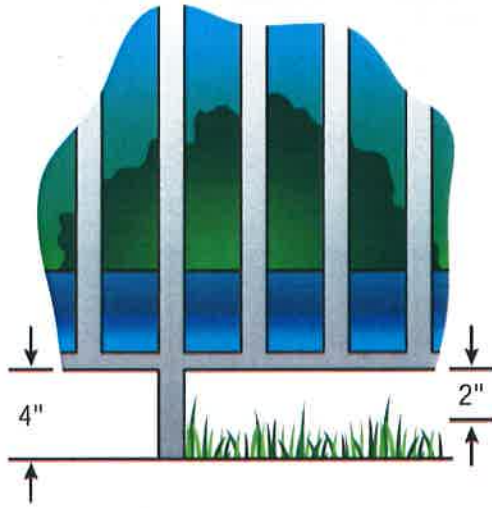

Figure 10

For any pool barrier, the maximum clearance at the bottom of the barrier should not exceed 4 inches above the surface or ground when the measurement is done on the side of the barrier facing away from the pool. Industry recommends that if the bottom of the gate or fence rests on a non-solid surface like grass or gravel, that measurement should not exceed 2 inches.

## How to Prevent a Child from Getting THROUGH a Pool Barrier

Preventing a child from getting through a pool barrier can be done by restricting the sizes of openings in a barrier and by using self-closing and self-latching gates.

To prevent a young child from getting through a fence or other barrier, all openings should be small enough so that a 4-inch diameter sphere cannot pass through. This size is based on the head breadth and chest depth of a young child.

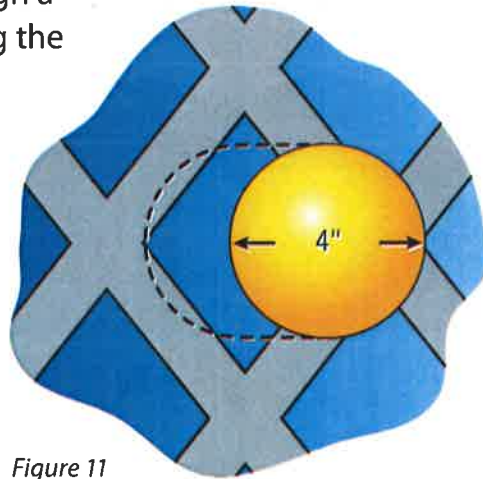

Figure 11

## Portable Pools



Portable pools are becoming more popular. They vary in size and height, from tiny blow-up pools to larger thousands-of-gallons designs. Portable pools present a real danger to young children.

Never leave children unsupervised around portable pools. It is recommended that portable pools be fenced, covered or emptied and stored away. Instruct neighbors, friends and caregivers about their presence and the potential dangers of a portable pool in your yard.

## Removable Mesh Fences

Mesh fences are specifically made for swimming pools or other small bodies of water. Although mesh fences are meant to be removable, the safest mesh pool fences are locked into the deck so that they cannot be removed without the extensive use of tools.



Like other pool fences, mesh fences should be a minimum of 48" in height. The distance between vertical support poles and the attached mesh, along with other manufactured factors, should be designed to hinder a child's ability to climb the fence. The removable vertical support posts should extend a minimum of 3 inches below grade and they should be spaced no greater than 40 inches apart. The bottom of the mesh barrier should not be more than 1 inch above the deck or installed surface.

*For more information on Removable Mesh Fencing see ASTM standard F 2286 – 05.*

## Gates

There are two kinds of gates which might be found on a residential property: pedestrian gates and vehicle or other types of gates. Both can play a part in the design of a swimming pool barrier. All gates should be designed with a locking device.



### Pedestrian Gates

These are the gates people walk through. Swimming pool barriers should be equipped with a gate or gates which restrict access to the pool.

Gates should open out from the pool and should be self-closing and self-latching. If a gate is properly designed and not completely latched, a young child pushing on the gate in order to enter the pool area will at least close the gate and may actually engage the latch.



Figure 12

The weak link in the strongest and highest fence is a gate that fails to close and latch completely. For a gate to close completely every time, it must be in proper working order.

When the release mechanism of the self-latching device on the gate is less than 54 inches from the bottom of the gate, the release mechanism for the gate should be at least 3 inches below the top of the gate on the side facing the pool. Placing the release mechanism at this height prevents a young child from reaching over the top of a gate and releasing the latch.

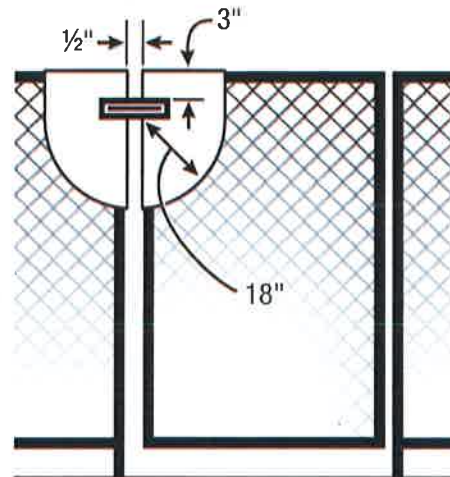

Figure 13

Also, the gate and barrier should have no opening greater than 1/2 inch within 18 inches of the latch release mechanism. This prevents a young child from reaching through the gate and releasing the latch.

### All Other Gates (Vehicle Entrances, Etc.)

Other gates should be equipped with self-latching devices. The self-latching devices should be installed as described for pedestrian gates.



## When the House Forms Part of the Pool Barrier

In many homes, doors open directly from the house onto the pool area or onto a patio leading to the pool. In such cases, the side of the house leading to the pool is an important part of the pool barrier. Passage through any door from the house to the pool should be controlled by security measures.

The importance of controlling a young child's movement from the house to pool is demonstrated by the statistics obtained in CPSC's submersion reports. Residential locations dominate in incidents involving children younger than 5 accounting for 85% of fatalities and 54 percent of injuries (from CPSC's 2012 *Pool and Spa Submersion Report*, see page 3).



Figure 14

### Door Alarms

All doors that allow access to a swimming pool should be equipped with an audible alarm which sounds when the door and/or screen are opened. Alarms should meet the requirements of *UL 2017 General-Purpose Signaling Devices and Systems, Section 77* with the following features:

- Sound lasting for 30 seconds or more within 7 seconds after the door is opened.
- The alarm should be loud: at least 85 dBA (decibels) when measured 10 feet away from the alarm mechanism.
- The alarm sound should be distinct from other sounds in the house, such as the telephone, doorbell and smoke alarm.
- The alarm should have an automatic reset feature to temporarily deactivate the alarm for up to 15 seconds to allow adults to pass through house doors without setting off the alarm. The deactivation switch could be a touchpad (keypad) or a manual switch, and should be located at least 54 inches above the threshold and out of the reach of children.

Self-closing doors with self-latching devices could be used in conjunction with door alarms to safeguard doors which give access to a swimming pool.

## Pet or Doggy Doors

Never have a pet or doggy door if the door leads directly to a pool or other backyard water. An isolation barrier or fence is the best defense when pet doors are installed. Remember, pet door openings, often overlooked by adults, provide curious children with an outlet to backyard adventure. Locking these doors is not sufficient and could lead to accidents and tragedies. Children regularly drown in backyard pools, which they were able to access through pet doors. Some municipalities have building codes that prohibit doggy doors in homes with pools unless there is an isolation fence around the pool.

## Power Safety Covers

Power safety covers can be installed on pools to serve as security barriers, especially when the house serves as the fourth wall or side of a barrier. Power safety covers should conform to the specifications in the *ASTM F 1346-91 standard*, which specifies safety performance requirements for pool covers to protect young children from drowning.



Figure 15

## Indoor Pools

When a pool is located completely within a house, the walls that surround the pool should be equipped to serve as pool safety barriers. Measures recommended for using door alarms, pool alarms and covers where a house wall serves as part of a safety barrier also apply for all the walls surrounding an indoor pool.



## Barriers for Residential Swimming Pool, Spas, and Hot Tubs

The preceding explanations of CPSC's pool barrier guidelines were provided to make it easier for pool owners, purchasers, builders, technicians, and others to understand and apply the guidelines to their particular properties or situations. Reading the following guidelines in conjunction with the diagrams or figures previously provided may be helpful. For further information, consult your local building department or code authority.

### Outdoor Swimming Pools

All outdoor swimming pools, including inground, above ground, or onground pools, hot tubs, or spas, should have a barrier which complies with the following:

1. The **top of the barrier** should be at least 48 inches above the surface measured on the side of the barrier which faces away from the swimming pool (figure 1).
2. The maximum **vertical clearance between the surface and the bottom of the barrier** should be 4 inches measured on the side of the barrier which faces away from the swimming pool. In the case of a non-solid surface, grass or pebbles, the distance should be reduced to 2 inches, and 1 inch for removable mesh fences (figures 1 and 10).
3. Where the top of the **pool structure is above grade or surface**, such as an above ground pool, the barrier may be at ground level, such as the pool structure, or mounted on top of the pool structure. Where the barrier is mounted on top of the pool structure, the maximum vertical clearance between the top of the pool structure and the bottom of the barrier should be 4 inches (figure 9).
4. **Openings in the barrier** should not allow passage of a 4-inch diameter sphere (figure 11).
5. **Solid barriers**, which do not have openings, such as a masonry or stone wall, should not contain indentations or protrusions except for normal construction tolerances and tooled masonry joints (figure 2).
6. Where the barrier is composed of **horizontal and vertical members** and the distance between the bottom and top horizontal members is less than 45 inches, the horizontal members should be located on the swimming pool side of the fence (figure 3).
7. **Spacing between vertical members** should not exceed 1¾ inches in width. Where there are decorative cutouts, spacing within the cutouts should not exceed 1¾ inches in width (figure 4).
8. **Maximum mesh size for chain link fences** should not exceed 1¼ inch square unless the fence is provided with slats fastened at the top or the bottom which reduce the openings to no more than 1¾ inches (figures 5 and 6).
9. Where the barrier is composed of **diagonal members**, such as a lattice fence, the maximum opening formed by the diagonal members should be no more than 1¾ inches (figure 7).
10. **Access gates** to the pool should be equipped with a locking device. Pedestrian access gates should open outward, away from the pool, and should be self-closing and have a self-latching device (figure 12). Gates other than pedestrian access

- gates should have a self-latching device. Where the release mechanism of the **self-latching device** is located less than 54 inches from the bottom of the gate,
- (a) the release mechanism should be located on the pool side of the gate at least 3 inches below the top of the gate and
  - (b) the gate and barrier should have no opening greater than ½ inch within 18 inches of the release mechanism (figure 13).
11. Where a **wall of a dwelling** serves as part of the barrier, one of the following should apply:
- (a) **All doors with direct access to the pool** through that wall should be equipped with an **alarm** which produces an audible warning when the door and its screen, if present, are opened. Alarms should meet the requirements of *UL 2017 General-Purpose Signaling Devices and Systems, Section 77*. For more details on alarms, see page 13.
  - (b) The pool should be equipped with a **power safety cover** which complies with ASTM F1346-91 listed below.
  - (c) Other means of protection, such as **self-closing doors with self-latching devices**, are acceptable so long as the degree of protection afforded is not less than the protection afforded by (a) or (b) described above.
12. Where an **above ground pool structure is used as a barrier** or where the barrier is mounted on top of the pool structure, and the means of access is a ladder or steps (figure 8a), then
- (a) **the ladder** to the pool or steps should be capable of being secured, locked or removed to prevent access (figure 8b), or
  - (b) **the ladder or steps should be surrounded by a barrier** (figure 8c). When the ladder or steps are secured, locked, or removed, any opening created should not allow the passage of a 4 inch diameter sphere.

## For more information on

### Fencing:

- **ASTM F 1908-08** *Standard Guide for Fences for Residential Outdoor Swimming Pools, Hot Tubs, and Spas*: <http://www.astm.org/Standards/F1908.htm>
- **ASTM F 2286-05** *Standard Design and Performance Specifications for Removable Mesh Fencing for Swimming Pools, Hot Tubs, and Spas*: <http://www.astm.org/Standards/F2286.htm>

### Covers:

- **ASTM F 1346-91** *Standard Performance Specification for Safety Covers and Labeling Requirements for All Covers for Swimming Pools, Spas and Hot Tubs*: <http://www.astm.org/Standards/F1346.htm>

*Note: ASTM Standards are available for a fee. You may want to contact a pool contractor.*

### And:

- **ASTM Standards**, contact ASTM online at: <http://www.astm.org/CONTACT/index.html>
- **UL** (Underwriters Laboratories) Relevant Pool and Spa Standards <http://www.ul.com/global/eng/pages/>, look for Life Safety and Security Product



CPSC's **Pool Safely: Simple Steps Save Lives** campaign provides advice and tips on drowning and entrapment prevention. Installing barriers is just one of the *Pool Safely* Simple Steps for keeping children safe around all pools and spas. Here are others:

## **Rule # 1: Never leave a child unattended around a pool, spa, bath tub, or any body of water.**

### **At pools, spas, and other recreational waters:**

- Teach children basic water safety skills.
- Learn how to swim and ensure your children know how to swim as well.
- Avoid entrapment by keeping children away from pool drains, pipes, and other openings.
- Have a phone close by at all times when visiting a pool or spa.
- If a child is missing, look for them in the pool or spa first, including neighbors' pools or spas.
- Share safety instructions with family, friends, babysitters, and neighbors.

### **If you have a pool:**

- Install a 4-foot fence around the perimeter of the pool and spa, including portable pools.
- Use self-closing and self-latching gates; ask neighbors to do the same if they have pools or spas.
- If your house serves as the fourth side of a fence around a pool, install and use a door or pool alarm and/or a pool or spa cover.
- Maintain pool and spa covers in good working order.
- Ensure any pool or spa you use has anti-entrapment safety drain covers; ask your pool service representative if you do not know.\*
- Have life saving equipment such as life rings, floats or a reaching pole available and easily accessible.

*\*The Virginia Graeme Baker Pool & Spa Safety Act, a federal law, requires all public pools and spas to have anti-entrapment drain covers and other devices, where needed. Residential pools are not required to install these but it is recommended that they do so.*

Visit **[www.PoolSafely.gov](http://www.PoolSafely.gov)** for more information. See CPSC's latest submersion reports: *Submersions Related to Non-pool and Non-spa Products, 2012* and *Pool and Spa Submersion Report, 2012*.

U.S. Consumer Product Safety Commission  
4330 East West Highway  
Bethesda, MD 20814

**Twitter:** @poolsafely

[www.PoolSafely.gov](http://www.PoolSafely.gov)

**Email:** [poolsafely@cpsc.gov](mailto:poolsafely@cpsc.gov)

